

Allesandro Volta



Luigi Galvani











Allesandro Volta



- | | |
|--|---|
| <i>a a a a</i> Verge de fer | <i>vi</i> Autre gouttière |
| <i>b b b</i> Perche | <i>l</i> Fiole longue |
| <i>c</i> Gouttière | <i>m</i> Fil de fer |
| <i>d</i> Table | <i>n</i> Tension du fil de fer |
| <i>e e e</i> Bouteilles à vin | <i>o o</i> Contacs de la verge de fer |
| <i>f</i> Planché quarré | <i>p p p</i> Entrelais cloués sur |
| <i>g g</i> Cordons de soye | le Perche |
| <i>h h h</i> Gouttières renversées | <i>q q q</i> Contages tenant lieu |
| | d'aubane |
| | <i>x</i> Pointe dorée de la verge |
| | de fer |

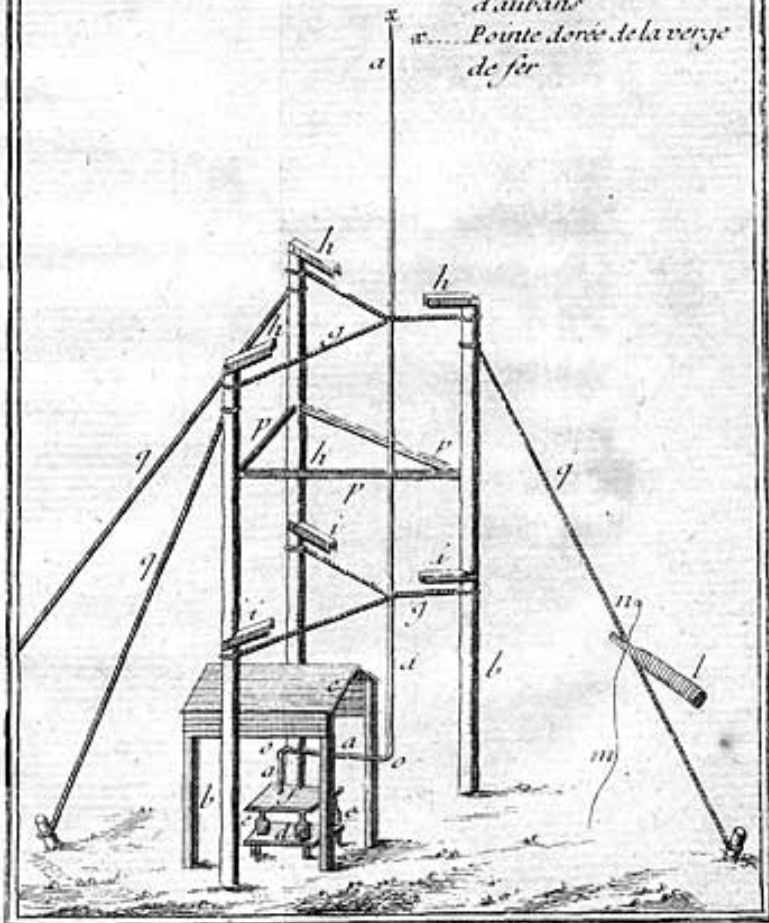



© Copyright The Royal Society

Volta's Electric Pistol

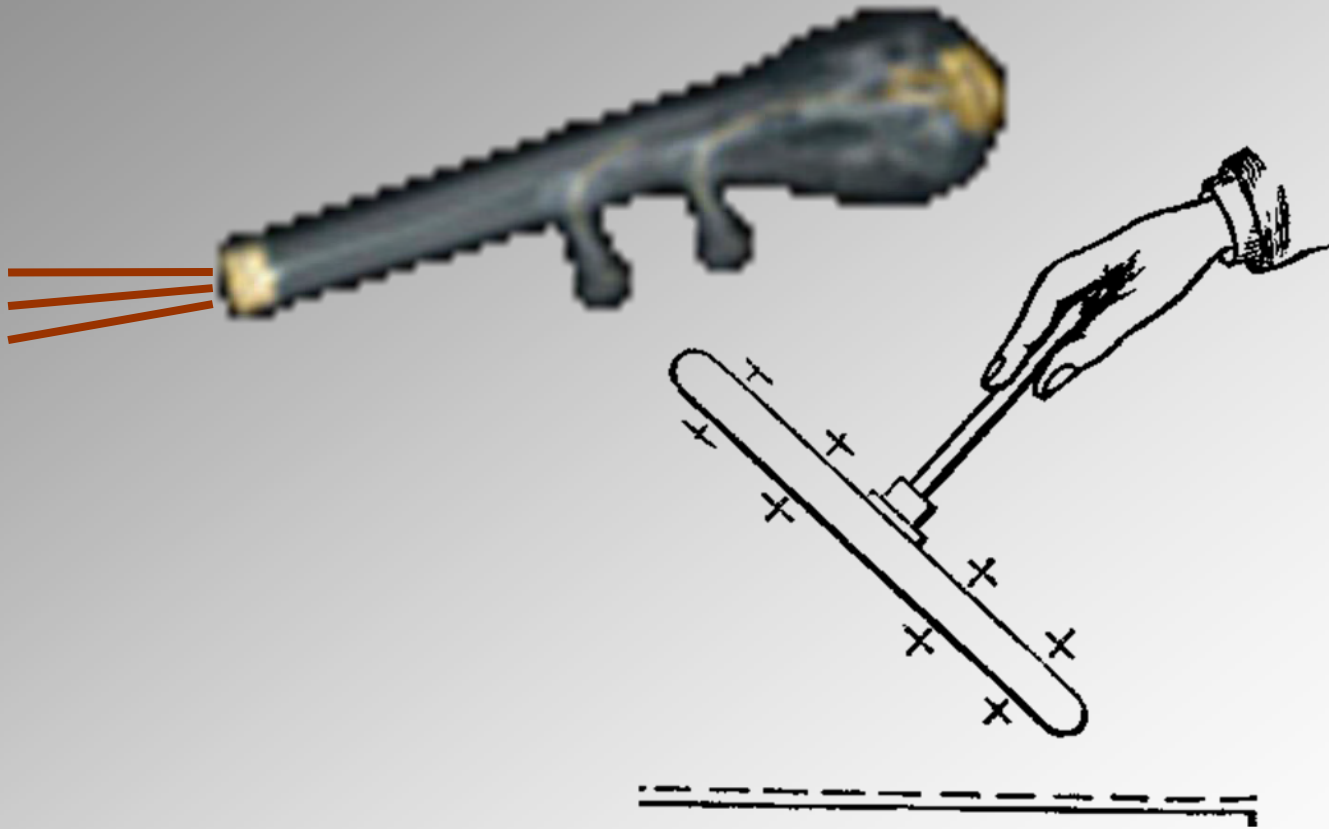



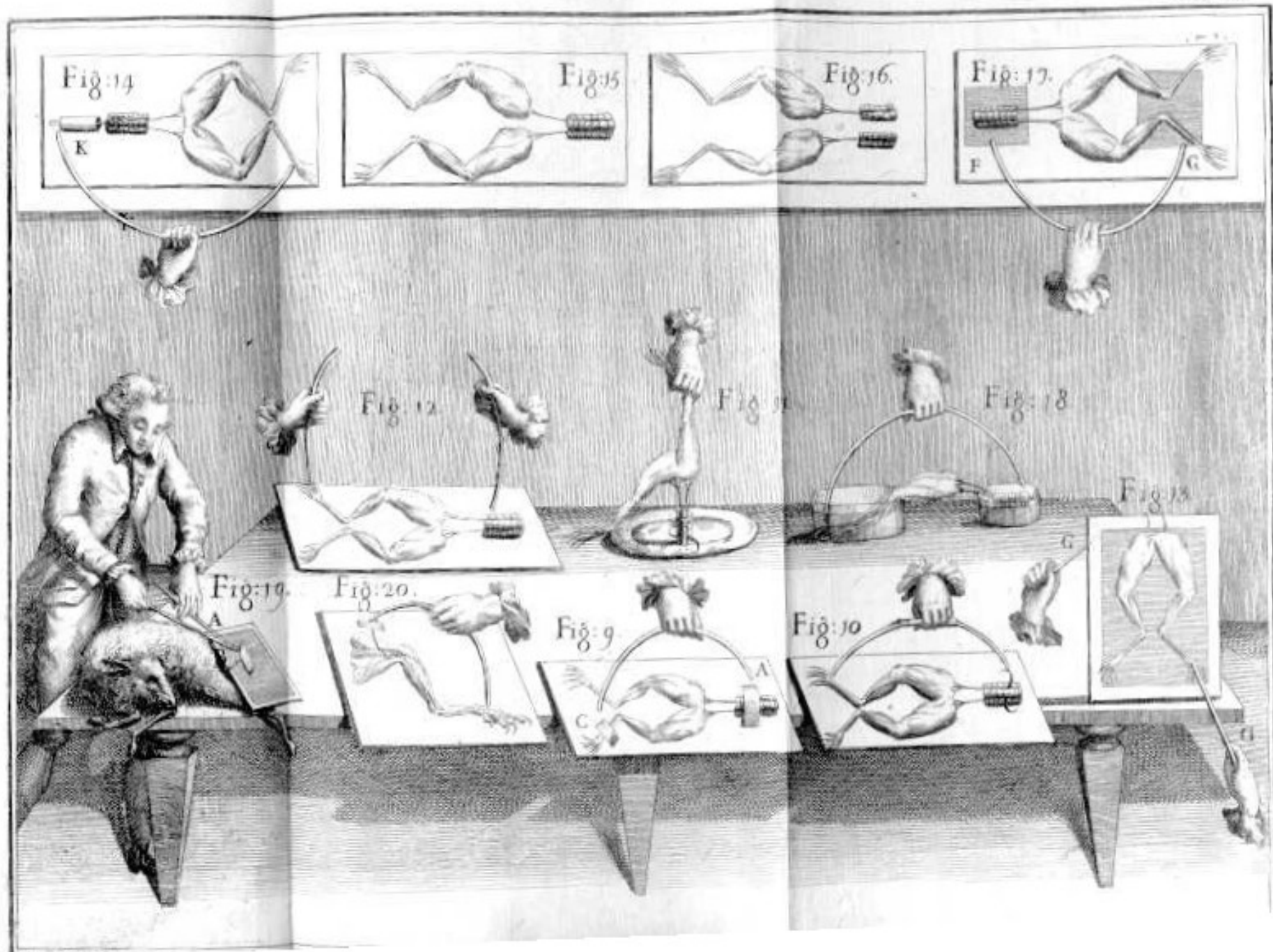

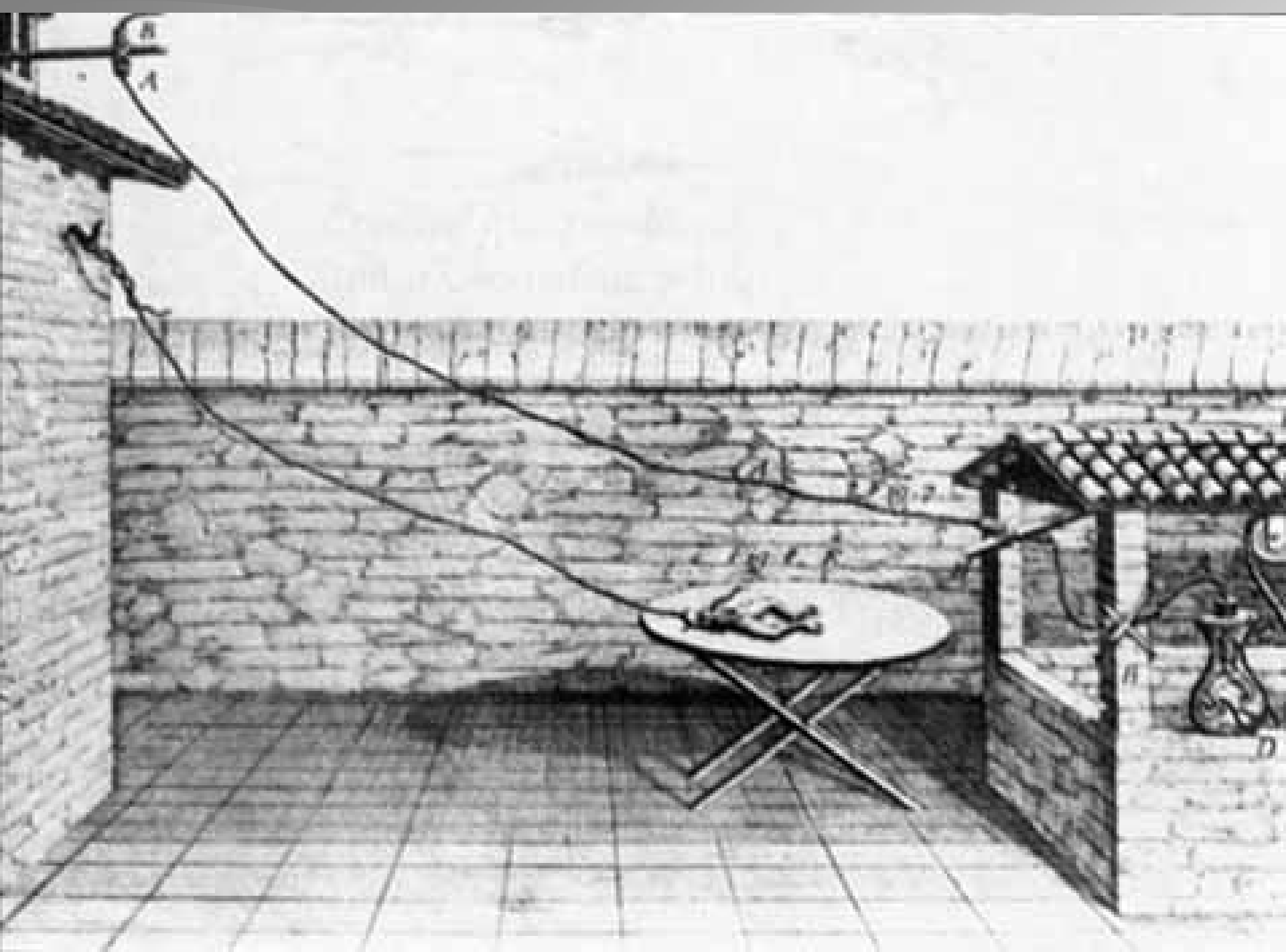

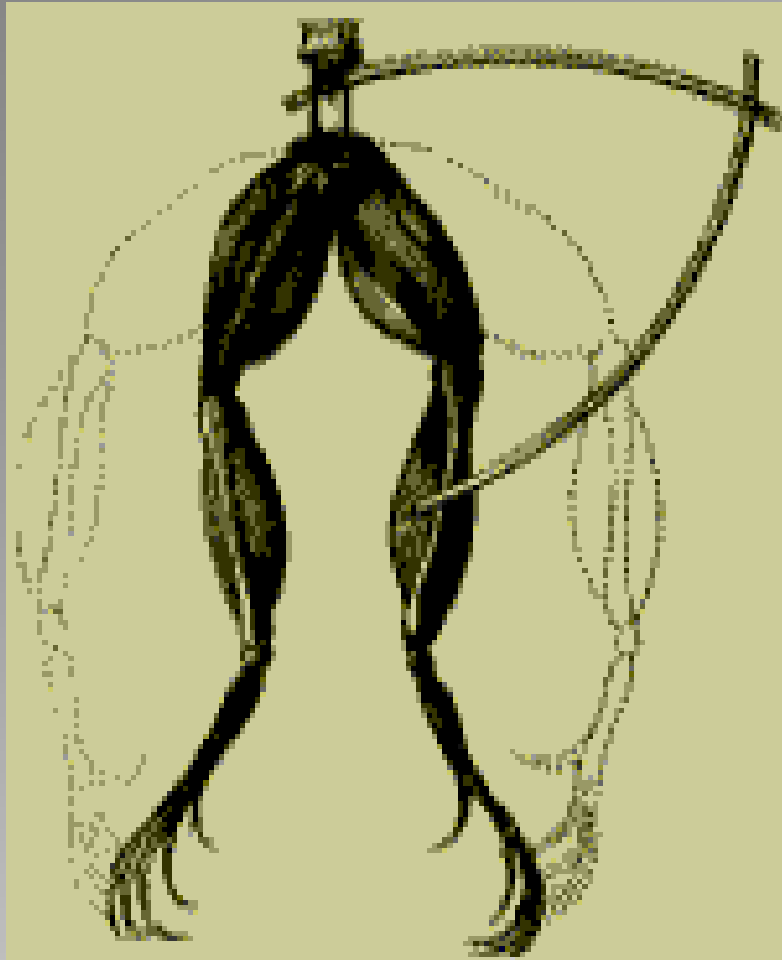

Fig. 1

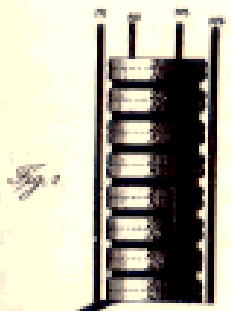

Fig. 2

Fig. 3

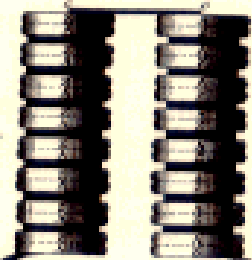
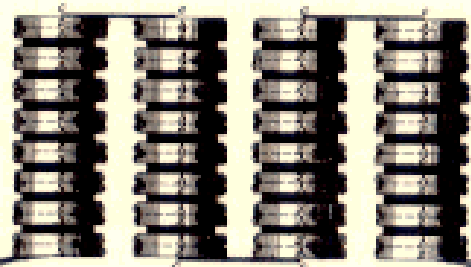

Fig. 4



Luigi Galvani



**Alessandro
Volta**